

Gigaset pro



R650 H PRO

BECAUSE IT'S YOUR BUSINESS.



---

## **Gigaset R650H PRO: The robust professional DECT handset for tough everyday conditions**

Gigaset pro handsets are optimised for use in commercial environments and form part of the professional Gigaset pro DECT IP systems.

This manual contains a description of all the functions your handset offers.

Please consult the relevant manual to discover the full functionality of a Gigaset pro DECT IP system.

You can also use your handset with the DECT GAP bases from other manufacturers:

### **On a DECT telephone/router/multicell system from other manufacturers with GAP compatibility**

Basic telephony functions are available in GAP mode.

For your further convenience, your R650H PRO offers a locally managed list of missed calls.

### **On DECT routers with CAT-iq 2.0**

Your Gigaset CAT-iq handset is certified in accordance with the DECT/CAT-iq 2.0 standard.

Handset functions on a CAT-iq router (amongst others):

- Convenient call-making and call lists,
- Wideband calls in HD Voice™ quality,
- Full access to the central directory in the router,
- Use of multiple lines and call numbers<sup>\*)</sup>.

➔ Details can be found in the user guide for your router.

<sup>\*)</sup> The relevant scope of the function is dependent on the country, network and router

## Overview of handset



- 1 **LED light / Visual call signal**  
(→ p. 33, → p. 33)
- 2 **Display in idle status**
- 3 **Status bar** (→ p. 38)  
Icons display current settings and operating status of the phone
- 4 **Volume keys** (→ p. 12)
- 5 **Display keys** (→ p. 12)
- 6 **End call key, on/off key**  
End call, cancel function, go back one menu level (press **briefly**), back to idle status (press and **hold**), switch handset on/off (press and **hold** in idle status)
- 7 **Message key** (→ p. 14)  
Access to the calls and message lists;  
**Flashing:** new message or new call
- 8 **Profile key** (→ p. 33)
- 9 **Hash key**  
Keypad lock on/off (press and **hold** in idle status);  
Toggles between upper/lower case and digits
- 10 **Connection socket for headset** (→ p. 8)
- 11 **Microphone**
- 12 **Star key**  
With an open connection: switch from pulse dialling to tone dialling (press **briefly**);  
When inputting text: Open special characters table
- 13 **Key 1**  
Select network mailbox (press and **hold**)
- 14 **Recall key**  
- Consultation call (flash)  
- Insert a dialling pause (press and **hold**)
- 15 **Answer call key / Handsfree key**  
Dial number displayed;  
Accept call; switch from earpiece to handsfree mode;  
Open the redial list (press **briefly**); start dialling (press and **hold**);
- 16 **Control key / Menu key** (→ p. 11)



The product images are depicted schematically and may differ from the actual appearance of the product.

# Contents

Overview of handset .....	2
Safety precautions .....	4
Illustration in the user guide .....	5
Getting started .....	6
Getting to know your phone .....	11
Making calls .....	16
Adjusting the telephone settings .....	19
Restoring phone to default setting .....	27
Multiple handsets .....	28
Phonebook (Address book) .....	29
Call list .....	32
Sound profiles .....	33
Spot LED .....	33
Calendar .....	34
Alarm clock .....	35
Room monitoring .....	36
Display icons .....	38
Menu tree .....	40
Service (Customer Care) .....	42
Environment .....	44
Appendix .....	45
Index .....	48



Not all functions described in the user guide are available in all countries or from all network providers.

## Safety precautions

Read the safety precautions and the user guide before use.



Comprehensive user guides for all telephones and telephone systems as well as for accessories can be found online at [gigasetpro.com](http://gigasetpro.com) in the Support category. We thereby help to save paper while providing fast access to the complete up-to-date documentation at any time.



Use only the power adapter indicated on the device.



Use only **rechargeable batteries** that correspond to the **specification** (see "Specifications"). Never use a conventional (non-rechargeable) battery or other battery types as this could result in significant health risks and personal injury. Rechargeable batteries, which are noticeably damaged, must be replaced.



Using your telephone may affect nearby medical equipment. Be aware of the technical conditions in your particular environment, e.g. doctor's surgery. If you use a medical device (e.g. a pacemaker), please contact the device manufacturer. They will be able to advise you regarding the susceptibility of the device to external sources of high frequency energy (for the specifications of your Gigaset pro product see "Specifications").



Do not hold the rear of the handset to your ear when it is ringing or when speaker mode is activated. Otherwise you risk serious and permanent damage to your hearing.

The phone may cause interference in analogue hearing aids (humming or whistling) or cause them to overload. If you require assistance, please contact the hearing aid supplier.



The base and charger are not splashproof. For this reason do not install them in a damp environment such as bathrooms or shower rooms.



Do not use the devices in environments with a potential explosion hazard (e.g. paint shops).



Remove faulty devices from use or have them repaired by our Service team, as these could interfere with other wireless services.







Do not use the device if the display is cracked or broken. Broken glass or plastic can cause injury to hands and face. Send the device to our Service department to be repaired.









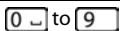

Emergency numbers **cannot** be dialled if the **keypad/display lock** is activated!

## Illustration in the user guide

	Warnings, which, if not heeded, can result in injury to persons or damage to devices.
	Important information regarding function and appropriate handling or functions that could generate costs.
	Prerequisite for being able to carry out the following action.
	Additional helpful information.









### Keys

	Talk key		Handsfree key
	End call key		Number / letter keys
	Control key rim / centre		Message key
	Recall key		Star key
	Hash key		Profile key
OK, Back, Select, Change, Save, ...		Display keys	

### Procedures

**Example:** Switching Auto answer on/off

▶  ▶ ... use  to select  **Settings** ▶ OK ▶  **Telephony** ▶ OK ▶ **Auto Answer** ▶ **Change**  (= on)

Step	Follow this procedure
▶ 	When in idle status press the <b>centre</b> of the control key. The main menu opens.
▶  	Navigate to the  icon using the control key  .
▶ OK	Select <b>OK</b> to confirm. The submenu <b>Settings</b> opens.
▶  <b>Telephony</b>	Select the <b>Telephony</b> entry using the control key  .
▶ OK	Select <b>OK</b> to confirm. The submenu <b>Telephony</b> opens.
▶ <b>Auto Answer</b>	The function to switch Auto answer on/off appears as the first menu item.
▶ <b>Change</b>	Select <b>Change</b> to activate or deactivate. Function is activated  /deactivated  .

---

## Getting started

---

### Checking the contents of the package

- One handset,
- One charging cradle incl. power adapter,
- One battery cover (rear cover for the handset),
- One locking disc for the battery cover,
- Two batteries,
- One belt clip,
- One rubber cover for the headset socket,
- Safety precautions.

---

### Installing the charging cradle

The charging cradle is designed for use in closed, dry rooms in a temperature range of +5°C to +45°C.

- ▶ Set up the charging cradle on a flat, non-slip surface.

The phone's feet do not usually leave any marks on surfaces. However, due to the multitude of different varnishes and polishes used on today's furnishings, marks on the surfaces cannot be completely ruled out.



- Never expose the telephone to the effects of heat sources, direct sunlight or other electrical devices.
- Protect your Gigaset from moisture, dust, corrosive liquids and fumes.

---

### Connecting the charging cradle

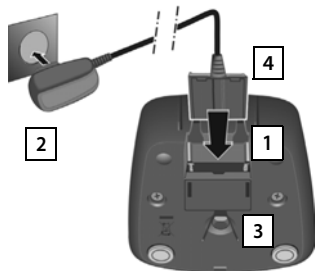

- ▶ Connect the flat plug to the charging cradle **1**.
- ▶ Plug the power adapter into the power socket **2**.

If you have to remove the plug from the charging cradle again:

- ▶ Disconnect the power adapter from the mains power supply.
- ▶ Press the release button **3** and disconnect the plug **4**.



## Setting up the handset for use

The display is protected by a plastic film. **Please remove the protective film!**

### Inserting the batteries and closing the battery cover



Use only rechargeable batteries recommended by Gigaset Communications GmbH (→ p. 46), as this could otherwise result in significant health risks and personal injury. For example, the outer casing of the batteries could be destroyed or the batteries could explode. The phone could also malfunction or be damaged as a result of using batteries that are not of the recommended type.

- ▶ Insert the batteries with the polarity in the right direction (for correct +/- direction, see diagram).
- ▶ Hold the battery cover at a slight angle and insert the bottom into the casing first **1**.
- ▶ Then press the cover **2** until it clicks into place.
- ▶ Insert the locking disc as shown (at an angle of approx. 20°) **3**. Pay attention to the arrow markings.
- ▶ Turn locking disc clockwise to the end stop **4**. The locking disc is closed once the markings on the disc are aligned with those on the cover **5**.

To **open the battery cover**, for example to change the batteries:

- ▶ Turn the locking disc anti-clockwise to the end stop **6** (approx. 20°) and remove **7**.
- ▶ Place your fingernail in the notch on the side between the cover and the casing **8** and remove the cover **9**.

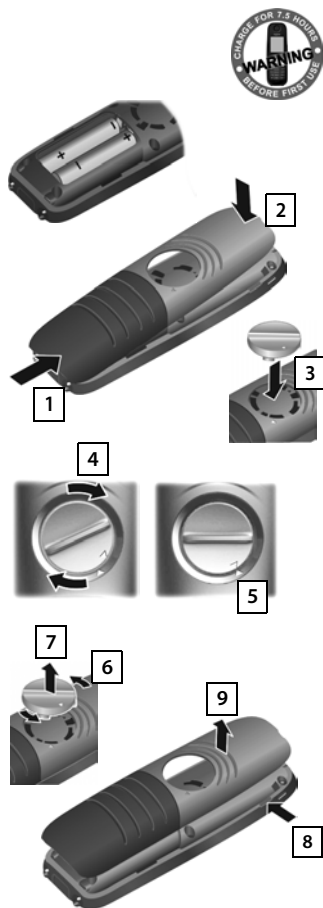

### Charging the batteries

The batteries are supplied partially charged. Please charge completely before use. (The batteries are fully charged when the power icon  disappears from the display.)

- ▶ Charge the handset in the charging cradle for **7.5 hours**.



- The handset may only be placed in the designated base/charging cradle.
- The battery may heat up during charging. This is not dangerous.
- After a time, the charge capacity of the battery will decrease for technical reasons.

### Belt clip

The handset has notches on each side to attach the belt clip.

- **To attach** — press the belt clip onto the back of the handset so that the tabs on the belt clip click into place in the notches.
- **To remove** — press the centre of the belt clip firmly with your right thumb, push the fingernail of your left thumb up between the clip and the casing and pull the clip in an upward direction.



### Connecting the headset



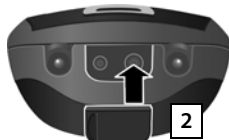

You can connect a headset to the underside of your telephone with the 2.5 mm jack connector **1**. For information on recommended headsets, see the relevant product page at [wiki.gigasetpro.com](http://wiki.gigasetpro.com).



If you **do not** wish to connect a headset, please insert the rubber cover supplied **2** to guarantee the unit is still splash proof.



## Changing the display language

Change the display language if you do not understand the language currently set.

- ▶  ▶ **6** ▶ **5** ▶  Select language ▶ Select ( = selected)

## Registering the handset

The registration process depends on the base. You must initiate registration on the handset **and** on the base. Both must be carried out **within 60 secs**.

- ▶ **On the base:** Press and **hold** (min. 3 secs) the Registration/paging key.
- ▶ **On the handset,** press the display key **Register**.  
Or:  
 ▶  ▶ **OK** ▶  **Registration** ▶ **OK** ▶ **Register Handset** ▶ **OK**

Display shows: **Searching for a base in registration mode**. The connection to the base will be established; this may take some time.

- ▶ Enter the system PIN if required (factory setting: **0000**). ▶ **OK**

When registering, the display screen shows: **Handset is registering**

After registering successfully, the display screen shows: **Handset registered**

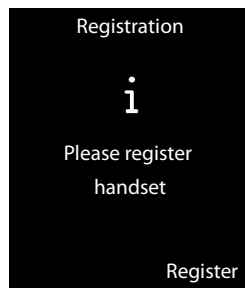

Your handset can be registered on up to four bases. To see how to use your handset with multiple bases and de-register a handset, refer to the user guide for the base.



For information on registering to a DECT IP multicell system, consult the relevant user guide at → [wiki.gigasetpro.com](http://wiki.gigasetpro.com)

## Setting the date and time

Set the date/time so that the correct date and time can be assigned to incoming calls, and so that you can use the alarm.

- ▶ Press the display key **Time**.  
Or:  
 ▶  ▶ **OK** ▶ **Date/Time** ▶ **OK**
- ▶ Setting the date and time:
- ▶ **Save**

**Your phone is now ready for use.**

## What would you like to do next?

After successfully setting up the phone, you can make calls straight away, customise your Gigaset according to your requirements or firstly familiarise yourself with the operation.

---

### Setting ringtones

Assign specific tunes to internal and external calls, reminders (→ p. 22), wake-up calls (→ p. 35) and to certain callers (→ p. 29).

---

### Protecting yourself against unwanted calls

Set your phone up so that it doesn't ring if there is an anonymous call or use the time control (→ p. 24).

---

### Adjusting your phone to your surroundings

Use 3 sound profiles to adjust your phone to a quiet or loud background (→ p. 33).

---

### Register an existing Gigaset pro handset and add it to the phonebook

Use available handsets to continue calling from your new base. Transfer directory entries from these handsets to your new handset (→ p. 31).

---

**If you have any questions about using your phone, please read the tips on troubleshooting (→ p. 42) or contact our Customer Service team (→ p. 42).**

## Getting to know your phone

### Switching the handset on/off

- ▶ Press and **hold** the End call key  in idle status to switch the handset on or off.

### Locking/unlocking the keypad

The keypad lock prevents any accidental use of the phone. If you press a key when the keypad is locked, a message is displayed.

- ▶ Press and hold the  key to lock or unlock the keypad.

If a call is signalled on the handset, the keypad automatically unlocks, and you can accept the call. It then locks again when the call is finished.





### Control key

In the description below, the side of the control key (up, down, right, left, middle) that you have to press in the different operating situations is marked in black, e.g.  for "press right on the control key".



The control key allows you to navigate within menus and entry fields. In idle status or during an external call, it has the following functions:



#### When the handset is in idle status

-  Open the phonebook.
-  or  Open the main menu.
-  Open list of handsets.

#### During an external call

-  Open the phonebook.
-  Initiate an internal consultation call.
-  Adjust the loudspeaker volume for earpiece and handsfree mode.

#### Functions when pressing the centre of the control key

The key has different functions, depending on the operating situation.

- **In idle status**, it opens the main menu.
- **In submenus, selection and entry fields**, the key takes on the function of the display keys **OK**, **Yes**, **Save**, **Select** or **Change**.



These instructions demonstrate opening the main menu by pressing the right of the control key and confirming the functions by pressing the appropriate display key. However, if you prefer, you can also press the middle of the control key.

## Volume keys



Press these keys on the right-hand side of the handset to set the volume for the **earpiece, ringtone, handsfree mode, alarm clock, appointments** and the **headset** depending on the situation.

---

## Display keys

The display keys have a function preset by default in idle status, but the keys can be re-assigned (→ p. 25).

The functions of the display keys change depending on the operating situation.

Example

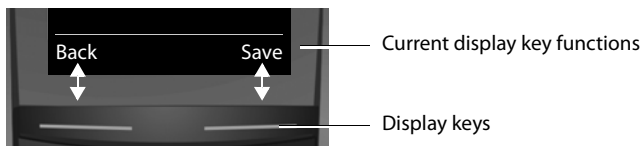

Some of the important display keys are:

- Options** Open a menu for further functions.
- OK** Confirm selection.
- Back** Skip back one menu level or cancel operation.
- Save** Save entry.

Overview of icons on the display keys → p. 38.

## Menu guidance

The functions of your telephone are displayed on a menu that consists of several levels. Menu overview → p. 40.

### Main menu (first menu level)

- ▶ When the handset is in idle status, press **right** on the control key  to open the main menu.

The main menu functions are shown in the display as icons. The icon for the selected function is highlighted and the name of the associated function appears in the display header.

Accessing a function, i.e. opening the corresponding submenu (next menu level):

- ▶ Use the control key  to navigate to the required function and press the display key **OK**.

Returning to idle status: **Briefly** press the display key **Back** or End call key .

Example

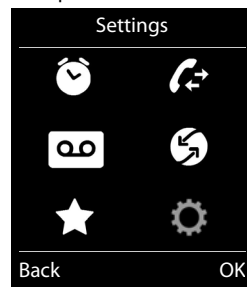

### Submenus

The functions in the submenus are displayed as lists.

To access a function:

- ▶ Scroll to the function using the control key  and press **OK**.

Returning to the previous menu level: **Briefly** press the display key **Back** or End call key .

Example

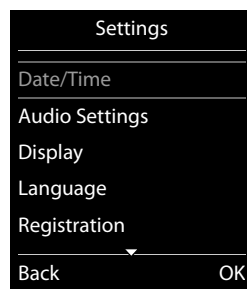

### Returning to idle status

From any menu:

- ▶ Press and **hold** the End call key .



Or:

- ▶ If you do not press a key, the display **automatically** returns to idle status after 2 minutes.

## Message lists

Any messages you receive are saved in the message lists. An advisory tone sounds as soon as a **new entry** appears on a list. The Message key also flashes. Icons for message types and the number of new messages are shown on the idle display.

New messages available:

-  On the answer machine (depending on the base)/network mailbox
-  In the missed calls list
-  In the missed alarms list

Open the message list by pressing the Message key . You can access the following message lists:

- **Answer Mach.:** Answer machine list (depending on the base)
- **Mailbox:** Network mailbox (if your network provider supports this function and the number of the network mailbox has been stored.)
- **Missed Calls:** Missed call list (see "Call list" → p. 32)
- **Missed Alarms:** Missed appointments list

The icon for the network mailbox is always displayed, provided the number is stored in the telephone. The other lists are only displayed if they contain messages.

**Opening the list:**  Select required list. ▶ OK

**Exception:** If you select the **network mailbox**, the number of the network mailbox will be selected. Lists are not opened on the display.

Example

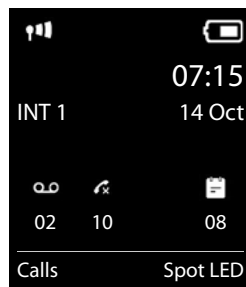





## Entering numbers and text

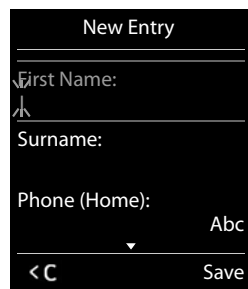





If several number and/or text fields are displayed (e.g. **First Name** and **Surname** in a phonebook entry), the field is automatically activated. The following fields must be activated by navigating with the control key . A field is activated when a cursor is blinking inside it.



## Correcting incorrect entries

- Deleting **characters** before the cursor: press the display key  **briefly**.
- Deleting **words** before the cursor: press and **hold** the display key .

## Entering text

- **Letters/Characters:** Multiple letters and characters are assigned to each key between  and . The characters are shown according to the key in a selection line at the bottom left of the display. The selected character is highlighted. Briefly press the key several times in succession to select the required letter/character.
- **Placing the cursor:** Letters/characters are inserted at the cursor position. You can insert the cursor by pressing the control key  or  in fields with multiple characters.
- **Typing lower case, upper case and numbers:** Press the hash key  to switch between lower case, upper case or numbers for the **following letters**. When editing a phonebook entry, the first letter and each letter following a space is automatically in upper case.
- **Special characters:** Press the star key  to open the special characters table. Navigate to the character desired using the star key and press the display key **Insert** to select it.
- **Special letters:** Umlauts or other marked/diacritic characters can be selected by pressing the corresponding letter several times. See the character table → p. 47.

## Making calls

### Making an external call

▶ Enter number, **briefly** press the Answer call key .

Or:

▶ Press and **hold** the Answer call key , enter number.

You can cancel the dialling process with the End call key .

### Dialling with the redial list

The redial list contains the 20 numbers last dialled with the handset. You can manage this similarly to your phone's message lists (→ p. 14).

▶ Press the Answer call key  **briefly** to open the redial list.

▶  Select entry. ▶ Press the Answer call key . The number is dialled.

When a name and corresponding phone number are displayed: Press the display key **View**.

### Managing entries in the redial list:



▶ Open redial list. ▶  Select entry. ▶ **Options**

You can select the following functions:

• **Copy to Directory** ▶ **OK**

Copy an entry to the phonebook (→ p. 29).

• **Display number** ▶ **OK**

Copy a number into the display and edit it or add to it, then select with  or save as a new entry in the phonebook with .





• **Delete entry** ▶ **OK**

Delete the selected entry.

• **Delete all** ▶ **OK**

Delete all entries.

### Dialling from the call list





▶  ▶  ▶ **OK** ▶  Select list. ▶ **OK** ▶  Select entry.  
▶  ▶ The number is dialled.

Example







- You can also bring up the call list using the display key **Calls**, but you must assign a display key accordingly (→ p. 25).
- You can also open the list **Missed calls** using the Message key .

## Dialling with the phonebook

- ▶  ▶  Select entry. ▶ 
- ▶ If multiple numbers are entered: Select the number with  and press the Answer call key  or OK. ▶ The number is dialled.



## One touch call

You can set up your phone so that you can dial a specific number when you press **any key on the keyboard**. This allows children, who are unable to enter a number, to call a certain number, for example.

- ▶  ▶  ▶ OK ▶  One Touch Call ▶ OK
- ▶ Activation:  On / Off
- ▶ Call to Enter or change the number that you wish to dial.
- ▶ Save

The activated One Touch Call appears on the idle display. The saved number is dialled by pressing any key. Press the End call key  to cancel dialling.

### Ending one touch call mode:





- ▶ Press the display key OFF. ▶ Press and hold the  key.
- Or:
- ▶ Press and hold the  key.



## Accepting a call

You have the following options:

- ▶ Press .
- ▶ If **Auto Answer** is switched on (→ p. 21), remove the handset from the charging cradle.

### Activate/deactivate Simple Auto Answer

In addition to using the Answer call key , you can also answer a call using the keys ...  
,  and .

- ▶  ▶  ▶ OK ▶  Telephony ▶ OK ▶  Easy Acceptance
- ▶ Change  (= activated)

**Please note:** Changes are only saved permanently in **Profile Personal** (→ p. 33).

## Handsfree mode

If you are going to let someone listen in, you should tell the other party that this is happening.

- ▶ Press .

Placing the handset in the charging cradle during a call:

- ▶ Press and hold  for a further 2 seconds while placing the handset in the charging cradle.

## Adjusting the loudspeaker volume

- Accessing the settings **via the menu**:





▶  ▶  ▶ OK ▶  Audio Settings ▶ OK ▶ Handset Volume ▶ OK

▶ **Earpiece:**  Volume can be set at 5 levels for the earpiece and headset.

▶ **Speaker:**  Set the volume at 5 levels.

▶ Save

- Accessing the settings **during a call** for the mode currently in use (handsfree, earpiece, headset):

▶ Press side keys  /  (→ p. 2) or control key  ▶ .

▶ The setting is saved automatically after 2 seconds or press the display key **Save**. The screen reverts back to its previous display.



Changes are only saved permanently in **Profile Personal** (→ p. 33).

---



## Switching the microphone on/off (muting)

If you turn the microphone off during a call, your caller can no longer hear you.

- ▶ Press  to switch the microphone on/off.
- 

## Setting the microphone sensitivity

**During a call:** There are four settings for the microphone sensitivity. With these settings you get better acoustics in noisy or echoing environments.

- ▶ Press and **hold** the  key ▶ ... set the microphone sensitivity with  ▶ **Save** ... the change is immediately effective and also applies to subsequent calls



If you do not save the setting, it only applies for the current call.

## Adjusting the telephone settings

The handset and base station are preconfigured, but you can change the settings to suit your individual requirements.

The settings can be changed via the menu **Settings** whilst on a call or in idle status.

### Date and time

To ensure you have the correct time for incoming calls and to use the alarm clock and calendar, for example, the date and time must be set.

If the date and time have not yet been set on the handset, the display key **Time** appears.

- ▶ Press the display key **Time**

or

- ▶ ▶ ... use to select **Settings** ▶ **OK** ▶ **Date/Time** ▶ **OK** ... then
  - Set the date: ▶ **Date:** ... use to enter the day, month and year in 8-digit format  
e.g. 1 4 0 1 2 0 1 6 for 14/01/2016
  - Set the time: ▶ **Time** ▶ ... use to enter hours and minutes in 4-digit format e.g. 0 7 1 5 for 07:15
  - Save settings: ▶ **Save**

### Changing the display language

- ▶ ▶ ▶ **OK** ▶ **Language** ▶ **OK** ▶ **Select languages** ▶ **Select** (= selected)

### Setting your country and local area codes

Your area code (international and local area code) must be saved on the phone before you can transfer phone numbers (e.g. in vCards). Some of these numbers are already preset. Please ensure that the prefix is correctly separated from the rest of the area code.

- ▶ ▶ ▶ **OK** ▶ **Telephony** ▶ **OK** ▶ **Area Codes**
  - ▶ **OK** ▶ Navigate to the entry field, delete the number using if needed ▶ Enter the number ▶ **Save**

#### Example

Area Codes

---

**International code:**  
00 - 49

---

**Local area code:**  
0 - [8, 1, ]

---







< C Save

## Adjusting the handset display settings

### Setting a screensaver

You can set a screensaver for the display when in idle status. You can choose from an analogue clock, a digital clock or an image.

To show the display in idle status, briefly press .

- ▶  ▶  ▶ OK ▶  Display ▶ OK ▶  
Screensaver (  = activated) ▶ Edit
- ▶ Activation:  On / Off
- ▶ Selection:  
 Digital Clock / Analog Clock / [Images]
- Or:  
▶ View (View screensaver) ▶  Select screensaver
- ▶ OK
- ▶ Save

### Example

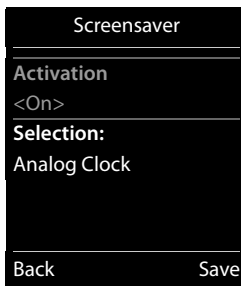

### Setting the colour scheme

You can set the display to show a dark or a light background.

- ▶  ▶  ▶ OK ▶  Display ▶ OK ▶  Colour Schemes ▶ OK ▶  Colour Scheme 1 / Colour Scheme 2 ▶ Select (  = selected)

### Setting the display backlight

The display backlight is always lit when the handset is not in the base/charging cradle or when a key is pressed. Any **digit keys** pressed appear on the display for pre-dialling.

You can also activate/deactivate the display backlight for idle status:

- ▶  ▶  ▶ OK ▶  Display ▶ OK ▶  Backlight ▶ OK
- In Charger:  On / Off
- Out of Charger:  On / Off
- ▶ Save



The handset's standby time can be significantly reduced if the display backlight is activated.







### Activating/deactivating visual call

Incoming calls are signalled visually (e.g. in noisy environments).

- ▶  ▶  ▶ OK ▶  Telephony ▶ OK ▶  LED Call Signal ▶ Change (  = activated)
- Please note:** Changes are only saved permanently in **Profile Personal** (→ p. 33).

## Activating/deactivating automatic keypad lock

Automatically lock the keypad when the handset has been in idle status for around 15 seconds.







- ▶  ▶ ... use  to select  **Settings** ▶ OK ▶  **Display & Keypad** ▶ OK ▶  **Auto Keypadlock** ▶ **Change**  = on)

Keypad lock with PIN protection: ▶ Set the handset PIN

## Changing the handset PIN

The handset is protected against unauthorised use by a PIN (default setting: 0000). The handset PIN must be entered e.g. when deactivating the keypad lock or when entering Bluetooth connections.

Change the telephone's 4-digit PIN (default setting: 0000):

- ▶  ▶ ... use  to select  **Settings** ▶ OK ▶  **System** ▶ OK ▶  **Handset PIN** ▶ OK ▶ ... use  to enter the current handset PIN ▶ OK ▶ ... use  to enter new handset PIN ▶ OK

## Activating/deactivating Auto Answer

When set to Auto Answer, the handset accepts an incoming call as soon as you remove it from the charging cradle.



- ▶  ▶  ▶ OK ▶  **Telephony** ▶ OK ▶ **Auto Answer** ▶ **Change**  = activated)

Regardless of the setting **Auto Answer**, the connection ends as soon as you place the handset back in the charging cradle. Exception: Press and hold  for a further 2 seconds while placing the handset in the charging cradle.

## Changing the earpiece and speaker volume

You can set the volume of the earpiece and speaker at 5 levels independently of each other.

### During a conversation

- ▶  **Handset Volume** ▶ ... use  to select volume ▶ **Save** ... the setting is saved



The setting is automatically saved after around 3 seconds without saving.



### In idle status

- ▶  ▶ ... use  to select  **Settings** ▶ OK ▶  **Audio Settings** ▶ OK ▶ **Handset Volume** ▶ OK ... then

For the earpiece:

- ▶ **Earpiece:** ... use  to set the volume

For the speaker:

- ▶  **Speaker** ▶ ... use  to set the volume

Save settings:

- ▶ **Save**



Changes are only saved permanently in **Profile Personal**.

## Earpiece and handsfree profile

Select a profile for the **earpiece** and **handsfree mode** in order to adapt the telephone as much as possible to the surroundings. Check which is the most comfortable profile for you and your caller.

- ▶ ▶ ... use to select **Settings** ▶ OK ▶ **Audio Settings** ▶ OK ▶ **Acoustic Profiles** ▶ **Earpiece Profiles / Handsfree Profiles** ▶ OK ▶ ... use to select profile ▶ Select = selected)

**Earpiece Profiles:** High or Low (default setting)

**Handsfree Profiles:** Profile 1 (default setting) ... Profile 2

## Setting the handset ringtones

### Setting the ringtone volume

- ▶ ▶ ▶ OK ▶ **Audio Settings** ▶ OK ▶ **Ringtones (Handset)** ▶ OK ▶ **Volume** ▶ OK
- ▶ **For internal calls and alarms:**
  - Volume can be set at 5 levels or crescendo (increasing volume) for internal calls and anniversaries.
- ▶ **External Calls:**
  - Volume can be set at 5 levels or crescendo (increasing volume) for external calls.
- ▶ **Save**

Example

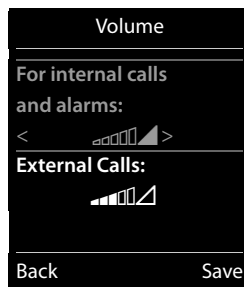

**When the telephone rings**, you can permanently change the ringtone volume using the side keys (louder) or (quieter).



**Please note:** Changes are only saved permanently in **Profile Personal** (→ p. 33).

### Setting the ring melody

- ▶ ▶ ▶ OK ▶ **Audio Settings** ▶ OK ▶ **Ringtones (Handset)** ▶ OK ▶ **Melodies** ▶ OK
- ▶ **Internal Calls:** Setting the volume/melody for internal calls and anniversaries.
- ▶ **External Calls:** Setting volumes/melodies for external calls.
- ▶ **Save**



## Activating/deactivating the ringtone

**Deactivating the ringtone permanently:** Using the Profile key , set the **Profile Silent** (→ p. 33).  appears in the status bar.

**Activating the ringtone permanently:** Using the Profile key,  set the **Profile Loud** or **Profile Personal** (→ p. 33).

Deactivating the ringtone for a **current call**: Press **Silence** or .

## Silent alert

Incoming calls and other messages are indicated by a silent alert.

▶  ▶  ▶ **OK** ▶  **Audio Settings** ▶ **OK** ▶  **Silent Alert** ▶ **Change**  = activated)

**Please note:** Changes are only saved permanently in **Profile Personal** (→ p. 33). This setting is saved in the **Profile Silent**.

## Activating/deactivating advisory tones

Your handset uses advisory tones to tell you about different activities and statuses. These advisory tones can be activated/deactivated independently of each other.

▶  ▶  ▶ **OK** ▶  **Audio Settings** ▶ **OK** ▶  **Advisory Tones** ▶ **OK**

▶ **Key Tones:**  **On / Off**

Tone when keys are pressed.

▶ **Confirmation:**  **On / Off**

Confirmation/error tone after making entries, advisory tone when a new message has been received.

▶ **Battery:**  **On / Off**

Warning tone when there are fewer than 10 minutes of talktime remaining (every 60 seconds). There is no battery warning when the room monitor is activated.

▶ **Out of Range:**  **On / Off**

Warning tone when the handset is moved out of range of the base station.

▶ **Save**

**Please note:** Changes are only saved permanently in **Profile Personal** (→ p. 33).

## Protection against unwanted calls

### Setting time control for external calls

You can specify a time period when you do not want the telephone to ring.

- ▶ ▶ ▶ OK ▶ Audio Settings ▶ OK
  - ▶ Ringtones (Handset) ▶ OK ▶ Time Control ▶ OK
- ▶ For external calls: On / Off

If activated:

- ▶ **Suspend ring. from:** Enter the start of the period.
- ▶ **Suspend ring. until:** Enter the end of the period.
- ▶ Save

#### Example

Time Control	
For external calls:	
On	
Suspend ring. from:	22:00
Suspend ring. until:	07:00
Back	Save



During this period, your phone will continue to ring for numbers to which you have assigned a VIP ringtone in the phonebook.

### Protection from anonymous callers

You can set your phone so that it doesn't ring for anonymous calls (callers who have withheld Calling Line Identification). The call is only signalled on the display. The setting only applies to handsets for which the setting is configured.

- ▶ ▶ ▶ OK ▶ Audio Settings ▶ OK ▶ Ringtones (Handset) ▶ OK
  - ▶ Anon. Calls Silent ▶ Change  = function activated)

### Switch off ringtone when in charging cradle

The handset will not ring when placed in the charging cradle. The call is only indicated on the display.

- ▶ ▶ ... use to select Settings ▶ OK ▶ Audio Settings ▶ OK ▶ Ringtones (Handset) ▶ OK ▶ Silent Charging ▶ Change  = ringtone is switched off when in charging cradle)

## Quick access to numbers and functions

The **digit keys** **0** and **2** up to **9** can be assigned to a **number from the phonebook**.

The left and right **display keys** have a **function** preset by default, but the keys can be re-assigned (→ p. 25).

You can then dial the number or start the function by simply pressing a key.

### Assigning digit keys

**Prerequisite:** You must assign a number to the digit key.

- ▶ Press and **hold** the digit key.  
Or:  
▶ **Briefly** press the digit key. ▶ Press the display key **QuickDial**.
- ▶ The phonebook opens. ▶  Select entry. ▶ **OK**

The entry is saved to the corresponding digit key.



If you delete or edit the entry in the phonebook at a later date, this will not affect the assignment to the number key.

### Selecting numbers/changing an assignment

**Prerequisite:** You must have assigned a number to the digit key.

When the handset is in idle status

- ▶ Press and **hold** the digit key: The number is dialed immediately.

Or:

- ▶ **Briefly** press the digit key: Press the left-hand display key with the number/name (abbreviated if necessary) to dial the number.

Or:

Press the display key **Change** to change the key assignment, or press the display key **Clear Key** to delete the assignment.

### Assigning display keys









- ▶ In idle status, press and **hold** the left or right-hand display key. ▶ The list of possible key assignments is opened. ▶  Select entry ▶ **OK**

Choose from the following functions:

<b>Room Monitor</b>	Set and activate the room monitor (→ p. 37).
<b>Alarm Clock</b>	Set and activate the alarm clock (→ p. 35).
<b>Calendar</b>	Open calendar (→ p. 34).
<b>One Touch Call</b>	Set up one touch call (→ p. 17).
<b>Redial</b>	Show redial list (→ p. 16).
<b>Spot LED:</b>	LED light (torch function) on/off (→ p. 33).
<b>More Functions...</b>	You can also choose further functions:
<b>Call Lists</b>	Show call list (→ p. 32).

### Changing the name of a connection (line)









(only on a CAT-iq router)

- ▶  ▶ ... use  to select  **Settings** ▶ OK ▶  **Telephony** ▶ OK ▶   
**Connections** ▶ OK ... all available connections (lines) are displayed ▶ ... use  to  
select connection ▶ OK ▶  **Connection Name** ▶ OK ▶ ... use  to change the name  
of the connection ▶ **Save**

### Assigning handsets to a connection (line)

(only on a CAT-iq router)







Multiple handsets can be assigned to a connection. Incoming calls to the number designated to a connection will be forwarded to all handsets assigned to the connection.

- ▶  ▶ ... use  to select  **Settings** ▶ OK ▶  **Telephony** ▶ OK ▶   
**Connections** ▶ OK ▶ ... use  to select connection ▶ OK ▶  **Assigned Handsets** ...  
all registered handsets are displayed ▶ ... use  to select handset ▶  
**Change**  = handset is assigned)

### Permit/prevent multiple calls

(only on a CAT-iq router)







If the function is activated, multiple calls can be made in parallel.

- ▶  ▶ ... use  to select  **Settings** ▶ OK ▶  **Telephony** ▶ OK ▶   
**Connections** ▶ OK ▶ ... use  to select connection ▶ OK ▶  **Multiple Calls** ▶  
**Change**  = on)

### Permit/prevent internal listening in

(only on a CAT-iq router)

If the function is enabled, an internal party can listen in to an external call and take part in the conversation (conference).

- ▶  ▶ ... use  to select  **Settings** ▶ OK ▶  **Telephony** ▶ OK ▶   
**Connections** ▶ OK ▶ ... use  to select connection ▶ OK ▶  **Listening In** ▶ OK ▶  
**Change**  = on)

### Handset update

(only on a CAT-iq router which supports updating of the handset firmware)

- ▶  ▶ ... use  to select  **Settings** ▶ OK ▶  **System** ▶ OK ▶  **Handset**  
**Update** ▶ OK ▶ **Update** ▶ OK ▶ OK ... updating of the handset firmware is carried out

## Restoring phone to default setting

You can reset individual modifications to handset settings.

The following are **not** affected by the reset:

- Date / time,
- Registration of handsets to the base and the current selection of the base,
- Entries in the calendar and phonebook,
- Redial list.

When resetting the handset (**Handset Reset**), audio and display settings will be deleted.

### Resetting the handset

- ▶  ▶  ▶ OK ▶  System ▶ OK ▶  Handset Reset ▶ OK ▶ Confirm security prompt with Yes



---

## Multiple handsets

---

### Making internal calls

Internal calls to other handsets registered to the same base are free of charge.



- ▶  (press **briefly**) ▶ The list of handsets is opened. Your own handset is marked <. ▶   
Select the handset or **Call all** (group call) from the list if required. ▶ 

**Holding down**  immediately starts a call on **all** registered handsets.

---

### Internal consultation/internal transfer

You receive a call from an **external** participant and would like to transfer the call to an **internal** participant or wish to consult him/her.

- ▶  ▶ The list of handsets is opened. ▶ If more than two handsets are registered to the base, select one handset or **Call all**. ▶  or **OK**

**Holding a consultation call:** You are speaking to the internal participant and are returning to your external call: ▶ **Options** ▶  **End active call** ▶ **OK**

**Transferring an external call:** You have two options to transfer the call:

- ▶ Wait until the participant called answers, then hang up:  
Press the End call key .

Or:



- ▶ Hang up before the participant calls: Press the End call key .

If the participant called does not answer or does not transfer the call, end the consultation with **End**.

---

### Establishing a conference call/call swapping

You are taking a call while a second call is being held. Both callers are indicated on the display.

- ▶ **Call swapping:** You can switch between both participants using .
- ▶ **Establishing a three-way conference call:** Press **Conf**.  
**Ending a conference call:** Press **End Conf**. You are reconnected with the external participant.  
You can switch again between both participants using .

Each of the callers can end their participation in the conference call by pressing the End call key .

---

### Accepting/rejecting call waiting

If you get an external call while conducting an internal call, you will hear the call waiting tone. If the number is transferred, you will see it or the name of the caller on the display.

- ▶ **Rejecting a call:** ▶ Press the display key **Reject**.
- ▶ **Accepting a call:** ▶ Press the display key **Accept**. You are now speaking to the new caller. The previous call is placed on hold.

**Ending the current call and returning to the call on hold:**

- ▶ **Options** ▶  **End active call** ▶ **OK**.

## Phonebook (Address book)

In a **phonebook entry**, you can store first names and surnames, up to three numbers, an anniversary with a reminder, and caller melody.



You can create the directory (with up to 200 entries) individually for each of your handsets. You can also send lists/entries to other handsets (→ p. 31).

### Length of the entries



3 numbers: Max. 32 digits each  
 First name and surname: Max. 16 characters each

## Managing directory entries

### Opening phonebook

Press the key  in idle status or, depending on the situation, the display key .

### Creating a new entry

- ▶ Open directory. ▶  <New Entry> ▶ OK
- ▶ Switch between the input fields using  and enter the relevant components of the entry (names, numbers, anniversary, ringtone).  
 Navigate downwards to display further components.
- ▶ Press the display key **Save**.

To create an entry, you must enter at least one number. If you have assigned a caller melody, the entry in the phonebook is supplemented with the symbol **VIP**.

Example

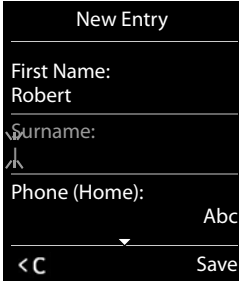

### Displaying/changing an entry

- ▶ Open phonebook. ▶  Select the desired entry. ▶ **View** ▶ Display all components of the entry. ▶ **Edit**

Or:

- ▶ **Options** ▶  Edit entry ▶ OK

### Deleting an entry

- ▶ Open phonebook. ▶  Select the desired entry. ▶ **Options** ▶  Delete entry ▶ OK

Delete **all** entries in the directory:

- ▶ Open phonebook. ▶ **Options** ▶  Delete List ▶ OK

### Defining the order of the contacts entries

You can define whether the entries are to be sorted by first name or surname.

- ▶ Open phonebook. ▶ **Options** ▶ Press **Sort by Surname** or **Sort by First Name**.

If no name was entered, the default number is shown in the surname field. These entries appear at the beginning of the list, regardless of how the entries are sorted.

The sort order is as follows:



Space | Digits (0-9) | Letters (alphabetical) | Other characters

---

### Displaying the number of entries that are available in the directory

- ▶ Open phonebook. ▶ **Options** ▶  **Available Memory** ▶ **OK**
- 

### Selecting a phonebook entry, searching in the phonebook

- ▶ Open phonebook.
- ▶ Scroll to the name you are searching for using . **Holding down**  scrolls continuously upwards or downwards through the phonebook.

Or:

- ▶ Enter the first few letters (max. 8 letters) using the keypad. The display jumps to the first name that begins with these letters. If necessary, scroll on to the desired entry using .



## Transferring an entry/phonebook to another handset

### Prerequisites:

- The sending and receiving handsets must both be registered to the same base.
- The other handset and the base can send and receive directory entries.

You can transfer the entire directory, an individual entry or several individual entries.



- An external call interrupts the transfer.
- Caller pictures and sounds are not transferred. Only the date is transferred for an anniversary.
- When transferring an entry between two vCard handsets:  
If the recipient does not yet have an entry with that name, a new entry is created. If there is already an entry with that name, this entry is expanded with the new numbers. If the entry contains more numbers than the recipient permits, a further entry is created with the same name.
- If the recipient is not a vCard handset: A separate entry is created and sent for each number.
- Your handset receives entries from a non-vCard handset: Entries with numbers that are already stored are discarded, otherwise a new entry is created.

### Transferring individual entries

- ▶ Open phonebook. ▶ Select the desired entry. ▶ Options ▶ Copy Entry ▶ OK  
▶ to Internal ▶ OK ▶ Select the recipient handset. ▶ OK

### Transferring the entire directory

- ▶ Open phonebook. ▶ Select the desired entry. ▶ Options ▶ Copy List ▶ OK ▶ to Internal ▶ OK ▶ Select the recipient handset. ▶ OK

## Transferring a displayed number to the phonebook

- ▶ The number is displayed or highlighted.
- ▶ Press display key or Options ▶ Copy to Directory. ▶ OK  
▶ <New Entry> ▶ OK ▶ Select number type. ▶ OK ▶ Complete the entry. ▶ OK
- Or:
- ▶ Select entry. ▶ OK ▶ Select number type. ▶ OK ▶ The number is entered or an existing number is overwritten (answer the prompt using Yes/No).
- ▶ Save







## Call list

Your telephone stores calls in various lists. Opening the lists:

- **Missed calls list:** Message key  ▶  **Missed Calls:** ▶ **OK**
- **List selection:**  ▶  ▶ **OK** ▶  Select list. ▶ **OK**

### List entry

The following information is displayed in the list entries:



- The list type (in the header row)
- Icon for the type of entry:  
 (Missed calls),  (Accepted calls),  (Outgoing calls)
- Caller's number. If the number is stored in the phonebook, name and number type are displayed instead ( Phone (Home),  Phone (Office),  Phone (Mobile)). For missed calls, the number of missed calls from this number is also shown in square brackets.
- Date and time of call (if set).

▶  Select entry. ▶ **Options**



▶ **View:** All available information is displayed, e.g. the corresponding number when a name is displayed.

▶ **Options:** You can delete the entry or transfer the number to the phonebook (→ p. 31).

### Calling back a caller from the call list:

▶  Select entry. ▶ Press the Answer call key .

### Example

All calls	
  James Foster Today, 18:35	
 01712233445566 11/06/2016, 18:30	
 0168123477945 10/06/2016, 17:13	
View	Options

## Sound profiles

You can call up the 3 sound profiles that are adapted for your handset to your surroundings consecutively by using the  key. The profile is switched immediately without a prompt. By default, **Profile Personal** is activated.

▶  ▶ Profile Loud ▶  ▶ Profile Silent ▶  ▶ Profile Personal

The profiles are set as follows by default:

Default setting		Profile Loud	Profile Silent	Profile Personal
Silent alert (→ p. 23)		On	like Profile Personal	Off
Ringer (→ p. 23)		On	Off	On
Ringtone volume (→ p. 22)	Internal	5	Off	3
	External	5	Off	3
Handset volume (→ p. 18)	Handset	5	3	3
	Handsfree	5	3	3
LED light for a call (→ p. 20)		Yes	No	No
Simple Auto Answer (→ p. 17)		Yes	No	No
Advisory tones (→ p. 23)	Key click	Yes	No	Yes
	Confirmation tone	Yes	No	Yes
	Battery tone	Yes	Yes	Yes

When switching to **Profile Silent** you can activate an alert tone by pressing the **Beep** display key.  appears in the status bar.

Changes in **Profile Loud** and **Profile Silent** only apply provided that the profile is not changed (by pressing the  Profile key). Changes to **Profile Personal** are stored permanently for this profile.

The set profile remains set when switching the phone off and back on.

## Spot LED

You can use your telephone as a torch.

### Activating/deactivating the torch function

▶ Press the **Spot LED** display key (→ p. 25).

Or:

▶  ▶  ▶ OK ▶ Spot LED ▶ OK

After 2 minutes the function is automatically deactivated or press the **OFF** display key.

## Calendar

You can remind yourself of up to **30 appointments**.

In the calendar, the current day is outlined in white; on days with appointments, the numbers are displayed in colour. When a day is selected, it will be highlighted.

July 2016						
Mo	Tu	We	Th	Fr	Sa	Su
				01	02	03
04	05	06	07	08	09	10
11	12	13	14	15	16	17
18	19	20	21	22	23	24
25	26	27	28	29	30	31
Back					OK	

## Saving appointments to the calendar

**Prerequisite:** Date and time are set (→ p. 9).

- ▶ ▶ ▶ OK ▶ Calendar ▶ OK ▶ Select the desired day. ▶ OK
- Appointments that have already been stored are shown.  
<New Entry> ▶ OK opens the window to enter an additional appointment.
- If no appointments have been entered, the data input window will open immediately to add the new appointment.

**Activation:** On/Off

The following information can be added:

- **Date:** The selected day is preset. Enter new data to change.
- **Time:** Time (hour and minute) of the appointment.
- **Text:** Appointment name (e.g. dinner, meeting).
- **Signal:** Select the melody of the reminder signal or deactivate the acoustic signalling.
- ▶ Save

## Signalling of appointments/anniversaries

Anniversaries are transferred from the phonebook and displayed as an appointment. An appointment/anniversary is displayed in idle status and signalled for 60 seconds with the selected ringtone.

**You can deactivate the reminder call:**

- ▶ Press OFF to acknowledge and end the reminder call.

**When you are on the phone,** a reminder call is indicated on the handset with a **single** advisory tone.



**During the reminder call** you can turn the ringtone volume (up) or (down) continuously using the side keys.



## Displaying missed appointments/anniversaries

The following appointments and anniversaries are stored in the **Missed Alarms** list:

- The appointment/anniversary call was not acknowledged.
- The appointment/anniversary was signalled during a phone call.
- The handset was switched off at the time of the appointment/anniversary.

The last 10 entries are stored. The  icon and the number of new entries are shown in the display. The most recent entry appears at the head of the list.

To open the list: ▶ Message key  ▶  **Missed Alarms** ▶ OK

Or via the menu:  ▶  ▶ OK ▶  **Missed Alarms** ▶ OK

▶  scroll in the list if required

Information about the appointment/anniversary is displayed. You can:

▶ Delete an appointment/anniversary: **Delete**

## Displaying/changing/deleting stored appointments

▶  ▶  ▶ OK ▶  **Calendar** ▶ OK ▶  Select the desired day. ▶ OK ▶ The appointment list is displayed. ▶  Select the desired appointment.

▶ **View:** Display appointment settings, change, if required using **Edit**.

Or:

▶ **Options:** Change settings or delete appointments.

- **Edit entry** ▶ OK
- **Delete entry** ▶ OK
- **Activate/Deactivate** ▶ OK
- **Delete all Appoints.** ▶ OK ▶ Confirm prompt with **Yes**.  
All appointments for the **selected day** are deleted.



## Alarm clock

**Prerequisite:** Date and time are set (→ p. 9).

You can activate/deactivate and set the alarm clock as follows:

▶  ▶  ▶ OK ▶ **Activation:**  **On/Off**

▶ Changing the settings:

- **Time:** Set the hour and minute for the wake-up time (time setting → p. 9).
- **Occurrence:**  **Daily/Monday-Friday**
- **Volume:**  Volume can be set at 5 levels or crescendo (increasing volume).
- **Melody:**  Select a ringtone for the alarm call.

▶ Press the display key **Save**.



When the alarm clock is activated, the icon  and the alarm time is displayed in idle status.

An alarm call is signalled in the display and with the selected ringtone for a maximum of 60 seconds. During a call, the wake-up call is only signalled by a short tone.

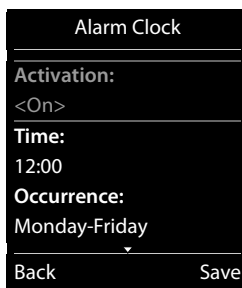
### Example



## Room monitoring

During the sounding of the alarm you can turn the volume  (up) or  (down) continuously using the side keys.

---

## Deactivating the alarm call/repeating after a pause (snooze mode)

**Prerequisite:** One alarm call sounds.

▶ **Deactivating until the next alarm call:** Press **OFF**.

Or:

▶ **Snooze mode:**

Press **Snooze** or any key. The wake-up call is deactivated and then repeated after 5 minutes.

Or:

Press nothing. The alarm call is deactivated after 60 seconds and then repeated after 5 minutes. After the fourth repetition, the alarm call is deactivated for 24 hours.

---

## Room monitoring

When the room monitor is switched on, the stored (internal or external) destination number is called as soon as a defined noise level is exceeded in the vicinity of the handset. The alarm to an external number is cancelled after approximately 90 seconds.

You can answer the alarm using the **Two Way Talk** function. This function is used to switch the loudspeaker of the handset located in the room being monitored on or off.

In room monitor mode, incoming calls are only indicated on the display (**without ringtone**). The display backlight is reduced to 50%. Advisory tones are deactivated. All keys are locked, with the exception of the display keys and the ability to press the centre of the control key.

If you accept an incoming call, the room monitor mode is suspended for the duration of the call, but the function **remains** activated. The room monitor mode is not deactivated by switching the handset off and on again.



The handset should be positioned 1 to 2 metres away from the area of the room being monitored. The microphone must point towards the area of the room being monitored.

Activating the function reduces the operating time of your handset. For that reason, place the handset in the charging cradle if necessary.

The room monitor is activated 20 seconds after switching on.

The answer machine for the destination number must be switched off.

After switching on:

- ▶ Test sensitivity.
- ▶ Test the connection, if the alarm is being forwarded to an external number.



## Activating and setting the room monitor

- ▶  ▶ ... use  to select  **Additional Features** ▶ **OK** ▶  **Room Monitor** ▶ **OK** ... then

Switch on/off:

- ▶ **Activation:** ... use  to select **On** or **Off**

Enter destination:



- ▶  **Send alarm to** ▶ ... use  to select **External** or **Internal**

**External:** ▶  **Number** ▶ ... use  to enter the number



or select a number from the directory: ▶ 

**Internal:** ▶  **Handset** ▶ **Change** ▶ ... use  to select the handset ▶ **OK**

Activate/deactivate two-way talk:

- ▶  **Two Way Talk** ▶ ... use  to select **On** or **Off**

Set microphone sensitivity:

- ▶  **Sensitivity** ▶ ... use  to select **High** or **Low**

Save settings: ▶ **Save**

The destination number is displayed in idle display when the room monitor is activated.

Room Monitor activated

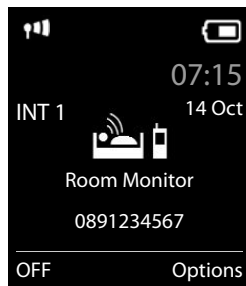

## Switching off/interrupting the alarm



Switch off the alarm: ▶ In idle status press the display key **OFF**

Interrupt the alarm: ▶ Press the End call key  during an alarm

## Deactivating the alarm remotely

### Prerequisites:

- The alarm is forwarded to an external destination number.
- The receiving phone supports tone dialling.
- If the alarm is activated via a VoIP connection, the DTMF signalling must take place via SIP info or RFC2833 (→ setting on the base station).

- ▶ Accept alarm call ▶ Press keys   ... the call is ended

The alarm is deactivated and the handset is in idle status. The room monitor settings on the handset (e.g. no ringtone) will remain activated until you press the display key **OFF**.

Reactivate room monitor with the same number: ▶ ... Reactivate (→ p. 37) ▶ **Save**

## Display icons

### Icons in the status bar

The following icons are displayed in the status bar depending on the settings and the operating status of your telephone:

Icon	Meaning
	Signal strength ( <b>No Radiation</b> off)
	76% - 100%
	51% - 75%
	26% - 50%
	1% - 25%
	Red: no connection to the base
	<b>No Radiation</b> activated: white, if <b>Maximum Range</b> is on; green, if <b>Maximum Range</b> is off
	<b>Profile Silent</b> activated (The ringtone is switched off)
	"Beep" ringtone activated
	Key lock

} White, if **Maximum Range** is on;  
Green, if **Maximum Range** is off

Icon	Meaning
	Battery charge status:
	White: charged over 66%
	White: charged between 34 and 66%
	White: charged between 11 and 33%
	Red: charged below 11%
	Flashes red: battery almost empty (approx. 5 minutes talktime remaining)
	Battery is charging (current charge status):
	0% - 10%
	11% - 33%
	34% - 66%
	67% - 100%

### Menu icons

	Alarm Clock
	Call Lists
	Answer Machine

	Select Services
	Additional Features
	Settings

### Display key icons

The following icons indicate the current function of the display keys according to the operating situation:

Icon	Action
	Last number redial
	Deleting text

Icon	Action
	Opening phonebook
	Copy number to the phonebook



## Display icons for signalling of



Establishing a call  
(outgoing call)



Connection  
established



No connection  
established/connection  
terminated



External call



Internal call



Reminder call for  
anniversary



Reminder call for  
appointment



Alarm call

## Other display icons



Information



(Security) prompt



Please wait...



Action complete  
(green)



Action failed (red)

## Menu tree

Opening the main menu: Press  whilst the telephone is in idle status.



Not all functions are available on all base stations, in all countries or from all network providers.

Depending on the number and type of available functions, you can display menus at top level or in a submenu, e. g. **Audio Settings** may be in a top-level menu or the **Settings** submenu.



**Alarm Clock**

→ p. 35



**Call Lists**

(depending on base)



**Answer Machine**

(depending on base)



**Select Services**

(depending on base)



**Additional Features**

Spot LED	→ p. 33
Calendar	→ p. 34
Room Monitor	→ p. 36
One Touch Call	→ p. 17
Missed Alarms	→ p. 35



**Settings**

Date/Time	→ p. 9												
Audio Settings	<table border="1"> <tr> <td>Handset Volume</td> <td>→ p. 18</td> </tr> <tr> <td>Acoustic Profiles</td> <td>→ p. 22</td> </tr> <tr> <td>Advisory Tones</td> <td>→ p. 23</td> </tr> <tr> <td>Silent Alert</td> <td>→ p. 23</td> </tr> <tr> <td>Ringtones (Handset)</td> <td>→ p. 22</td> </tr> <tr> <td colspan="2">(further submenus depending on base)</td> </tr> </table>	Handset Volume	→ p. 18	Acoustic Profiles	→ p. 22	Advisory Tones	→ p. 23	Silent Alert	→ p. 23	Ringtones (Handset)	→ p. 22	(further submenus depending on base)	
Handset Volume	→ p. 18												
Acoustic Profiles	→ p. 22												
Advisory Tones	→ p. 23												
Silent Alert	→ p. 23												
Ringtones (Handset)	→ p. 22												
(further submenus depending on base)													
Display	<table border="1"> <tr> <td>Screensaver</td> <td>→ p. 20</td> </tr> <tr> <td>Colour Schemes</td> <td>→ p. 20</td> </tr> <tr> <td>Backlight</td> <td>→ p. 20</td> </tr> <tr> <td>Auto Keypadlock</td> <td>→ p. 21</td> </tr> </table>	Screensaver	→ p. 20	Colour Schemes	→ p. 20	Backlight	→ p. 20	Auto Keypadlock	→ p. 21				
Screensaver	→ p. 20												
Colour Schemes	→ p. 20												
Backlight	→ p. 20												
Auto Keypadlock	→ p. 21												
Language	→ p. 19												
Registration	<table border="1"> <tr> <td>Register Handset</td> <td>→ p. 9</td> </tr> <tr> <td colspan="2">(further submenus depending on base)</td> </tr> </table>	Register Handset	→ p. 9	(further submenus depending on base)									
Register Handset	→ p. 9												
(further submenus depending on base)													

Telephony	Auto Answer → p. 21
	Easy Acceptance → p. 17
	LED Call Signal → p. 20
	Area Codes → p. 19
	(further submenus depending on base)
System	Reset Handset → p. 27
	(further submenus depending on base)





## Service (Customer Care)

Questions? For rapid assistance, refer to this user guide or visit [gigasetpro.com](http://gigasetpro.com). The trade outlet will be happy to help with further questions relating to your Gigaset R650H PRO.

### Questions and answers

If you have any queries about the use of your telephone, suggested solutions are available on our web-site at → [wiki.gigasetpro.com](http://wiki.gigasetpro.com) ▶ FAQ.

The table below also lists steps for troubleshooting.

<p><b>You are not sure whether your device is equipped with an integrated answer machine.</b></p> <p>▶ Open the answer machine menu:  ▶  ▶ OK</p> <p>Your device is equipped with an integrated answer machine if the submenu <b>Activation</b> is available.</p>
<p><b>The display is blank.</b></p> <ol style="list-style-type: none"><li>1. The handset is not activated. ▶ <b>Hold down</b> .</li><li>2. The battery is empty. ▶ Charge the battery or replace it (→ p. 7).</li><li>3. The key and display lock is activated. ▶ <b>Hold down</b> the hash key .</li></ol>
<p><b>"No Base" flashes on the display.</b></p> <ol style="list-style-type: none"><li>1. The handset is outside the range of the base. ▶ Move the handset closer to the base.</li><li>2. The base is not activated. ▶ Check the base power adapter.</li><li>3. The base's range is reduced because <b>Maximum Range</b> is deactivated. ▶ Activate <b>Maximum Range</b> or reduce the distance between the handset and base.</li></ol>
<p><b>"Please register handset" or "Place handset in base" flashes on the display.</b></p> <p>The handset has not yet been registered or was de-registered due to the registration of an additional handset (more than six DECT registrations).</p> <p>▶ Register the handset again (→ p. 9).</p>
<p><b>Your settings are not accepted.</b></p> <p>▶ Ensure that you have set the <b>Profile Personal</b> before you make changes to the device settings (→ p. 33).</p>
<p><b>The handset does not ring.</b></p> <ol style="list-style-type: none"><li>1. The ringtone is deactivated. ▶ Activate ringtone (→ p. 23).</li><li>2. Call forwarding is set. ▶ Deactivate call forwarding.</li><li>3. The phone does not ring if the caller has withheld his number. ▶ Activate the ringtone for unknown calls (→ p. 24).</li><li>4. The phone does not ring during a specific period or for certain numbers. ▶ Check time control for external calls (→ p. 24).</li></ol>
<p><b>The other party cannot hear you.</b></p> <p>The handset is "muted".</p> <p>▶ Activate the microphone again (→ p. 18).</p>

**The caller's number is not displayed.**

1. **Calling Line Identification (CLI)** is not approved for the caller.
  - ▶ The **caller** should ask the network provider to enable Calling Line Identification (CLI).
2. **Caller display (CLIP)** is not supported by the network provider or is not enabled for you.
  - ▶ Caller display (CLIP) is enabled by the network provider.
3. Your telephone is connected via a PABX or a router with an integrated PABX (gateway) that does not transmit all information.
  - ▶ Reset the system: Briefly pull out the power plug. Reinsert the plug and wait until the device restarts.
  - ▶ Check the settings on the PABX and activate phone number display, if necessary. To do this, search for terms such as CLIP, calling line identification, phone number identification, caller ID, etc. in the system's user guide or ask the system manufacturer.

**You hear an error tone when keying an input.**

Action has failed/invalid input.

- ▶ Repeat the process.
- ▶ Read the display and refer to the user guide if necessary.

**You cannot listen to messages on the network mailbox.**

Your PABX is set to pulse dialling.

- ▶ Set your PABX to tone dialling.

---

## Authorisation

This device is intended for use worldwide. Use outside the European Economic Area (with the exception of Switzerland) is subject to national approval.

Country-specific requirements have been taken into consideration.

We, Gigaset Communications GmbH, declare that this device meets the essential requirements and other relevant regulations laid down in Directive 1999/5/EC.

A copy of the Declaration of Conformity is available at this Internet address:  
[gigasetpro.com/docs](http://gigasetpro.com/docs)

**CE 0682**

---

## Environment

---

### Our environmental mission statement

We, Gigaset Communications GmbH, bear social responsibility and are actively committed to a better world. Our ideas, technologies and actions serve people, society and the environment. The aim of our global activity is to secure sustainable life resources for humanity. We are committed to a responsibility for our products that comprises their entire life cycle. The environmental impact of products, including their manufacture, procurement, distribution, utilisation, service and disposal, are already evaluated during product and process design.

Further information on environmentally friendly products and processes is available on the Internet at [gigasetpro.com](http://gigasetpro.com).

---

### Environmental management system



Gigaset Communications GmbH is certified pursuant to the international standards ISO 14001 and ISO 9001.

**ISO 14001 (Environment):** Certified since September 2007 by TÜV SÜD Management Service GmbH.

**ISO 9001 (Quality):** Certified since 17/02/1994 by TÜV SÜD Management Service GmbH.

---

### Disposal

Batteries should not be disposed of in general waste. Observe the local waste disposal regulations, details of which can be obtained from your local authority.

All electrical and electronic products should be disposed of separately from the municipal waste stream via designated collection facilities appointed by the government or the local authorities.



This crossed-out wheeled bin symbol on the product means the product is covered by the European Directive 2002/96/EC. The correct disposal and separate collection of your old appliance will help prevent potential negative consequences for the environment and human health. It is a precondition for reuse and recycling of used electrical and electronic equipment.

For more detailed information about disposal of your old appliance, please contact your local council refuse centre or the original supplier of the product.

---

## Appendix

---

### Care

Wipe the device with a **damp** cloth or an antistatic cloth. Do not use solvents or microfibre cloths.

**Never** use a dry cloth; this can cause static.

In rare cases, contact with chemical substances can cause changes to the device's exterior. Due to the wide variety of chemical products available on the market, it was not possible to test all substances.

Impairments in high-gloss finishes can be carefully removed using display polishes for mobile phones.

---

### Contact with liquid

Your handset is splash proof.

If it comes into contact with water, knock the water out of the microphone opening and remove any water on the handset with an absorbent cloth. Your handset is ready for use.

If your handset comes into contact with a larger amount of liquid take the following steps:

- 1 **Disconnect the power supply.**
- 2 **Remove the batteries and leave the battery compartment open.**
- 3 Allow the liquid to drain from the device.
- 4 Pat all parts dry.
- 5 Place the device in a dry, warm place **for at least 72 hours** (**not** in a microwave, oven etc.) with the battery compartment open and the keypad facing down (if applicable).
- 6 **Do not switch on the device again until it is completely dry.**

When it has fully dried out, you will normally be able to use it again.

## Technical data

### Batteries

Technology:	2 x AAA NiMH
Voltage:	1.2 V
Capacity:	800 mAh

### Handset operating times/charging times

The operating time of your Gigaset depends on the capacity and age of the battery and the way it is used. (All times are maximum possible times).

Standby time (hours) *	310 * 200 **
Talktime (hours)	14
Operating time for 1.5 hours of calls per day (hours) *	130 * 100 **
Charging time in charging cradle (hours)	7.5

\*No Radiation deactivated, without display backlight in idle status

\*\*No Radiation activated, without display backlight in idle status

### Power consumption of the handset in the charging cradle

When charging:	approx. 1.5 W
To maintain the charge status:	approx. 0.5 W

### General specifications

#### DECT

DECT standard	Supported
CAT-iq standard	Certified in accordance with standard CAT-iq 2.0 with HD Voice <a href="http://dect.org/cat-iq-certification.aspx">dect.org/cat-iq-certification.aspx</a>
GAP standard	Supported
No. of channels	60 duplex channels
Radio frequency range	1880-1900 MHz
Duplex method	Time division multiplexing, 10 ms frame length
Repetition frequency of the transmission pulse	100 Hz
Duration of the transmission pulse	370 µs
Channel grid	1728 kHz
Bit rate	1152 kbit/s
Modulation	GFSK
Language code	32 kbit/s
Transmission power	10 mW average power per channel, 250 mW pulse power
Range	Up to 50 m indoors, up to 300 m outdoors
Environmental conditions for operation	+5°C to +45°C, 20% to 75% relative humidity



## Character charts

### Standard characters

Press the relevant key the number of times indicated.

	1x	2x	3x	4x	5x	6x	7x	8x	9x	10x
1 <small>sp</small>	1									
2 <small>acc</small>	a	b	c	2	ä	á	à	â	ã	ç
3 <small>sup</small>	d	e	f	3	ë	é	è	ê		
4 <small>sup</small>	g	h	i	4	ï	í	ì	î		
5 <small>sup</small>	j	k	l	5						
6 <small>sup</small>	m	n	o	6	ö	ñ	ó	ò	ô	õ
7 <small>sup</small>	p	q	r	s	7	ß				
8 <small>sup</small>	t	u	v	8	ü	ú	ù	û		
9 <small>sup</small>	w	x	y	z	9	ÿ	ý	æ	ø	å
0 <small>sup</small>	<small>␣</small> <sup>1)</sup>	.	,	?	!	<small>↵</small> <sup>2)</sup>	0			

- 1) Space
- 2) Line break

# Index

- A**
- Address book, see Phonebook
  - Advisory tones . . . . . 23
  - Alarm (room monitor)
    - switch off . . . . . 37
  - Alarm clock . . . . . 35
  - Anniversary . . . . . 29
    - displaying missed . . . . . 35
  - Anonymous calls off . . . . . 24
  - Answer call key . . . . . 2
  - Answer machine
    - answer machine list . . . . . 14
  - Appointment
    - displaying missed . . . . . 35
  - Area code
    - setting own area code . . . . . 19
  - Assigning number key . . . . . 25
  - Authorisation . . . . . 43
  - Auto Answer . . . . . 21
    - simple . . . . . 17
- 
- B**
- Backlight, display . . . . . 20
  - Base
    - setting up . . . . . 6
  - Base station
    - changing the settings . . . . . 19
  - Battery
    - charging . . . . . 8
    - charging status . . . . . 38
    - display . . . . . 2
    - icon . . . . . 2
    - inserting . . . . . 7
  - Birthday, see Anniversary
  - Broken display . . . . . 4
- 
- C**
- Call
    - accepting . . . . . 17
    - accepting automatically . . . . . 21
    - external . . . . . 16
    - internal . . . . . 28
    - transferring (connecting) . . . . . 28
    - transferring internally (connecting) . . . . . 28
  - Call lists . . . . . 32
    - deleting an entry . . . . . 32
  - Call protection . . . . . 24
  - Call signal, visual . . . . . 20
  - Call waiting
    - external during an internal call . . . . . 28
    - internal during an external call . . . . . 28
  - Calling
    - external . . . . . 16
    - internal . . . . . 28
  - Care . . . . . 45
  - Care of the device . . . . . 45
  - Changing
    - display language . . . . . 9
      - handset PIN . . . . . 21
    - the phone settings . . . . . 19
    - the settings . . . . . 19
  - Character charts . . . . . 47
  - Charge status indicator . . . . . 2
  - Charge status of the batteries . . . . . 38
  - Charging cradle (handset)
    - connecting . . . . . 6
    - setting up . . . . . 6
  - Charging time of handset . . . . . 46
  - Charging, silent . . . . . 24
  - Colour scheme . . . . . 20
  - Connecting the headset . . . . . 8
  - Connection
    - assigning handset . . . . . 26
    - changing name . . . . . 26
  - Consultation call
    - internal . . . . . 28
  - Contact with liquid . . . . . 45
  - Contents of the package . . . . . 6
  - Control key . . . . . 2, 11
  - Correcting incorrect entries . . . . . 15
  - Correction of incorrect entries . . . . . 15
  - Customer Care . . . . . 42
- 
- D**
- Default setting . . . . . 27
  - Dialling
    - from the call list . . . . . 16
    - using speed dial . . . . . 25
    - using the redial list . . . . . 16
    - with directory . . . . . 17
  - Directory
    - saving entry . . . . . 29
  - Display
    - backlight . . . . . 20
    - broken . . . . . 4
    - changing display language . . . . . 9
    - colour scheme . . . . . 20
    - network mailbox message . . . . . 14
    - phonebook memory . . . . . 30
    - screensaver . . . . . 20
    - setting . . . . . 20
    - setting the backlight . . . . . 20
  - Display icons . . . . . 38
  - Display keys . . . . . 2, 12
    - assigning . . . . . 25
    - icons . . . . . 38
  - Displays
    - missed appointments/anniversaries . . . . . 35
  - Disposal . . . . . 44

- 
- E**
- Earpiece profile . . . . . 22
  - Earpiece volume . . . . . 18
  - End call key . . . . . 2
  - End call/End key . . . . . 16
  - Ending a conference call . . . . . 28
  - Entering special characters . . . . . 15
  - Entering special letters . . . . . 15
  - Entering text . . . . . 15
  - Entering umlauts . . . . . 15
  - Environment . . . . . 44
  - External call
    - transferring internally (connecting) . . . . . 28
  - External calls
    - time control for ringtone . . . . . 24
- 
- F**
- Factory settings . . . . . 27
  - Field strength . . . . . 38
- 
- G**
- Getting started . . . . . 6
- 
- H**
- Handset
- advisory tones . . . . . 23
  - assigning connection . . . . . 26
  - automatic keypad lock . . . . . 21
  - changing the PIN . . . . . 21
  - changing the settings . . . . . 19
  - colour scheme . . . . . 20
  - connecting the charging cradle . . . . . 6
  - display backlight . . . . . 20
  - display language . . . . . 9, 19
  - earpiece volume . . . . . 18
  - idle status . . . . . 13
  - list . . . . . 11
  - muting . . . . . 18
  - registering . . . . . 9
  - restoring to default setting . . . . . 27
  - screensaver . . . . . 20
  - setting . . . . . 19
  - setting up . . . . . 7
  - speaker volume . . . . . 18
  - switching on/off . . . . . 11
  - transferring a call . . . . . 28
  - use as a room monitor . . . . . 36
  - use for room monitoring . . . . . 36
  - using multiple . . . . . 28
- Handsfree mode . . . . . 17
  - Handsfree profile . . . . . 22
  - Handsfree volume . . . . . 18
  - Hash key . . . . . 2
  - Headset socket . . . . . 8
  - Hearing aids . . . . . 4
  - Help . . . . . 42
- 
- I**
- Icon
    - alarm clock . . . . . 35
  - Icons
    - displaying new messages . . . . . 14
    - on display keys . . . . . 38
    - status bar . . . . . 38
  - Idle status
    - returning to . . . . . 13
  - Internal
    - making calls . . . . . 28
  - Internal call . . . . . 28
  - call waiting . . . . . 28
  - Internal consultation call . . . . . 28
  - Internal listening in . . . . . 26
- 
- K**
- Key
- assigning to a function or number . . . . . 25
  - Profile key . . . . . 2
  - Key 1 (fast access) . . . . . 2
  - Keypad lock, automatic . . . . . 21
- Keys
- Answer call key . . . . . 2
  - control key . . . . . 2, 11
  - display keys . . . . . 2, 12
  - End call key . . . . . 2
  - End call/End key . . . . . 16
  - fast access . . . . . 2
  - Hash key . . . . . 2
  - Message key . . . . . 2
  - On/off key . . . . . 2
  - profiles . . . . . 33
  - Recall key . . . . . 2
  - side key . . . . . 12
  - Star key . . . . . 2
  - Volume key . . . . . 12
- 
- L**
- Language
- display . . . . . 9
- LED light . . . . . 33
  - Line . . . . . 26
  - Liquid . . . . . 45
- List
- accepted calls . . . . . 32
  - answer machine . . . . . 14
  - call lists . . . . . 32
  - handsets . . . . . 11
  - missed calls . . . . . 32
  - outgoing calls . . . . . 32
  - List entry . . . . . 32
  - Locking/unlocking the keypad . . . . . 11
  - Lower/upper case . . . . . 15

- 
- M**
- Making calls
    - accepting a call . . . . . 17
    - external . . . . . 16
    - internal . . . . . 28
  - Managing the calendar . . . . . 34
  - Marked characters . . . . . 15
  - Medical equipment . . . . . 4
  - Melody
    - ringtone for internal/external calls . . . . . 22
  - Memory in the phonebook . . . . . 30
  - Menu
    - opening . . . . . 11
    - tree . . . . . 40
  - Message key . . . . . 2
  - Message lists . . . . . 14
    - opening . . . . . 14
  - Microphone . . . . . 2
  - Microphone sensitivity . . . . . 18
  - Missed anniversaries/appointments . . . . . 35
  - Missed call . . . . . 32
  - Multiple calls . . . . . 26
  - Muting the handset . . . . . 18
- 
- N**
- Number
    - copying to the phonebook . . . . . 31
  - Numbers
    - entering . . . . . 15
- 
- O**
- On/off key . . . . . 2
  - One touch call . . . . . 17
  - Operating time of handset . . . . . 46
  - Order in the phonebook . . . . . 30
- 
- P**
- Phone
    - restoring to default setting . . . . . 27
    - setting . . . . . 19
  - Phonebook . . . . . 29
    - copying number from text . . . . . 31
    - opening . . . . . 11
    - order of entries . . . . . 30
    - sending entry/list to handset . . . . . 31
    - sending to handset . . . . . 31
  - Power adapter . . . . . 4
  - Profile key . . . . . 2, 33
  - Profiles . . . . . 33
  - Protection against unwanted calls . . . . . 24
  - Protection from anonymous callers . . . . . 24
  - Protection from calls
    - switch off ringtone when in charging cradle . . . . . 24
- 
- Q**
- Questions and answers . . . . . 42
- 
- R**
- Recall key . . . . . 2
  - Redial list . . . . . 16
  - Registering (handset) . . . . . 9
  - Restoring to default setting . . . . . 27
  - Restoring to factory settings . . . . . 27
  - Ringtone
    - changing . . . . . 22
    - melody for internal/external calls . . . . . 22
    - silencing for anonymous calls . . . . . 24
    - switch off when in charging cradle . . . . . 24
    - time control for external calls . . . . . 24
  - Ringtones . . . . . 22
  - Room monitor . . . . . 36
    - activation . . . . . 37
  - Room monitoring . . . . . 36
- 
- S**
- Safety precautions . . . . . 4
  - Saving a number in the directory . . . . . 29
  - Screensaver . . . . . 20
  - Searching
    - in directory . . . . . 30
  - Selecting an entry from the phonebook . . . . . 30
  - Sending
    - phonebook entry to handset . . . . . 31
  - Service . . . . . 42
  - Setting an appointment . . . . . 34
  - Setting options
    - phone . . . . . 19
  - Setting the date . . . . . 9, 40
  - Setting the display language . . . . . 19
  - Setting the time . . . . . 9, 40
  - Setting up
    - handset . . . . . 7
  - Side key . . . . . 12
  - Signal tone, see Advisory tones
  - Silent alert . . . . . 23
  - Silent charging . . . . . 24
  - Simple Auto Answer . . . . . 17
  - Snooze mode (alarm) . . . . . 36
  - Sound profiles . . . . . 33
  - Sound, see Ringtone
  - Speaker . . . . . 17
  - Speed dial . . . . . 25
  - Star key . . . . . 2
  - Status bar . . . . . 2
    - icons . . . . . 38
  - Switching microphone (handset) on/off . . . . . 18
- 
- T**
- Technical data . . . . . 46
  - Technical data, see Internet/CD
  - Telephone
    - operating . . . . . 11
  - Three-way conference call
    - ending . . . . . 28

Time control	
ringtone for external calls . . . . .	24
Torch function . . . . .	33
Transferring an external call internally . . . . .	28
Troubleshooting	
general . . . . .	42
<hr/>	
<b>U</b>	
Upper/lower case . . . . .	15
<hr/>	
<b>V</b>	
Viewing network mailbox message . . . . .	14
VIP ringtone . . . . .	29
Visual call signal . . . . .	2, 20
Volume	
earpiece . . . . .	21
handset handsfree/earpiece volume . . . . .	18
speaker . . . . .	21
Volume key . . . . .	12
<hr/>	
<b>W</b>	
Warning tone, see Advisory tones	

**Issued by**

Gigaset Communications GmbH  
Frankenstr. 2a, 46395 Bocholt

© Gigaset Communications GmbH 2016

Subject to availability.

All rights reserved. Rights of modifications reserved.

[www.gigasetpro.com](http://www.gigasetpro.com)